



Instructions
Notice de montage
Bauanleitung
Istruzioni di montaggio
Instrucciones de montaje
Instruções de montagem
Monteringsanvisning
Kokoamisohje
Monterings instruktioner
Montagehandleiding

Οδηγίες συναρμολόγησης.
組立説明書



#8650

人 8-88

p.6

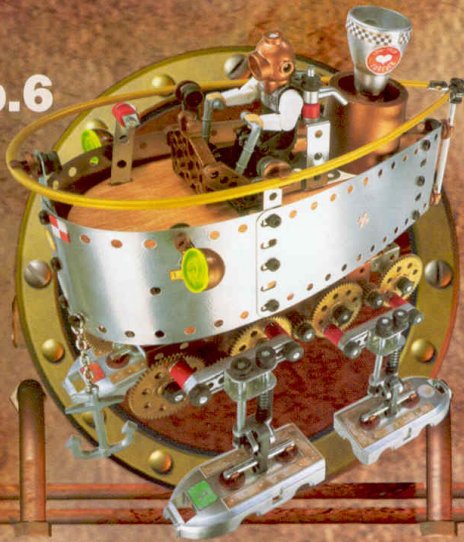



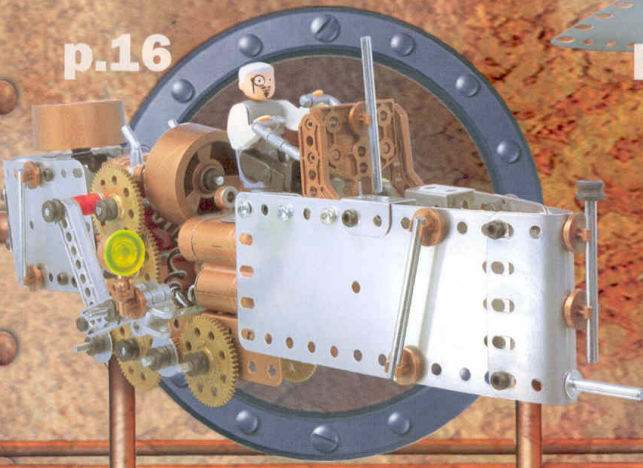

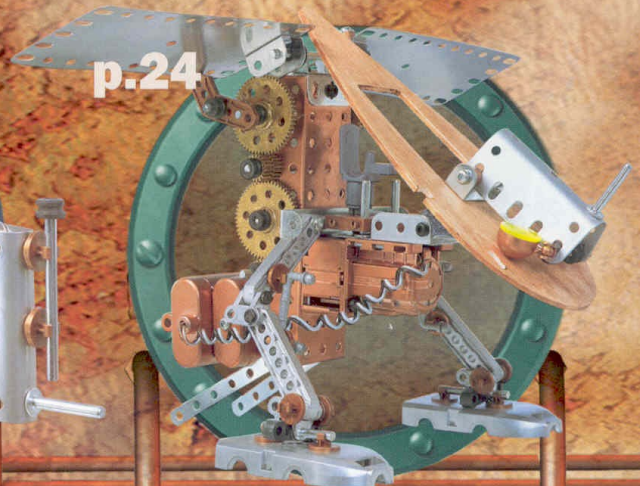

p.16



p.24



-  Use paint to customise your models.*
-  Personnalise tes modèles avec de la peinture.*
-  Personalisiere Deine Modelle mit Lack.*
-  Personalizza i tuoi modelli con della vernice.*
-  Personaliza tus modelos con pintura.*
-  Personaliza os teus modelos pintando-os.*

-  Personanpassa dina modeller med målarfärg.*
-  Tee malleista yksilöllisiä maalilla.*
-  Vælg selv modellernes farver.*
-  Individualiseer je modellen met verf.*
-  Δώσ προσωπικό τόνο στα μοντέλα σου βάφοντάς τα.*
-  塗料を使って、御自分の好みに合わせて、モデルを作って下さい.*



* Not included. * Non incluse. * Nicht enthalten.

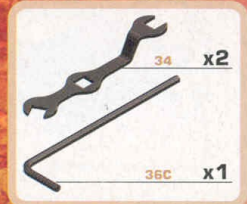
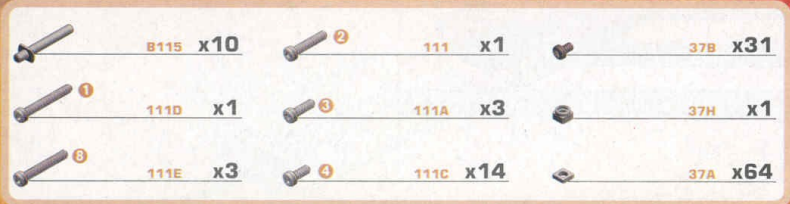
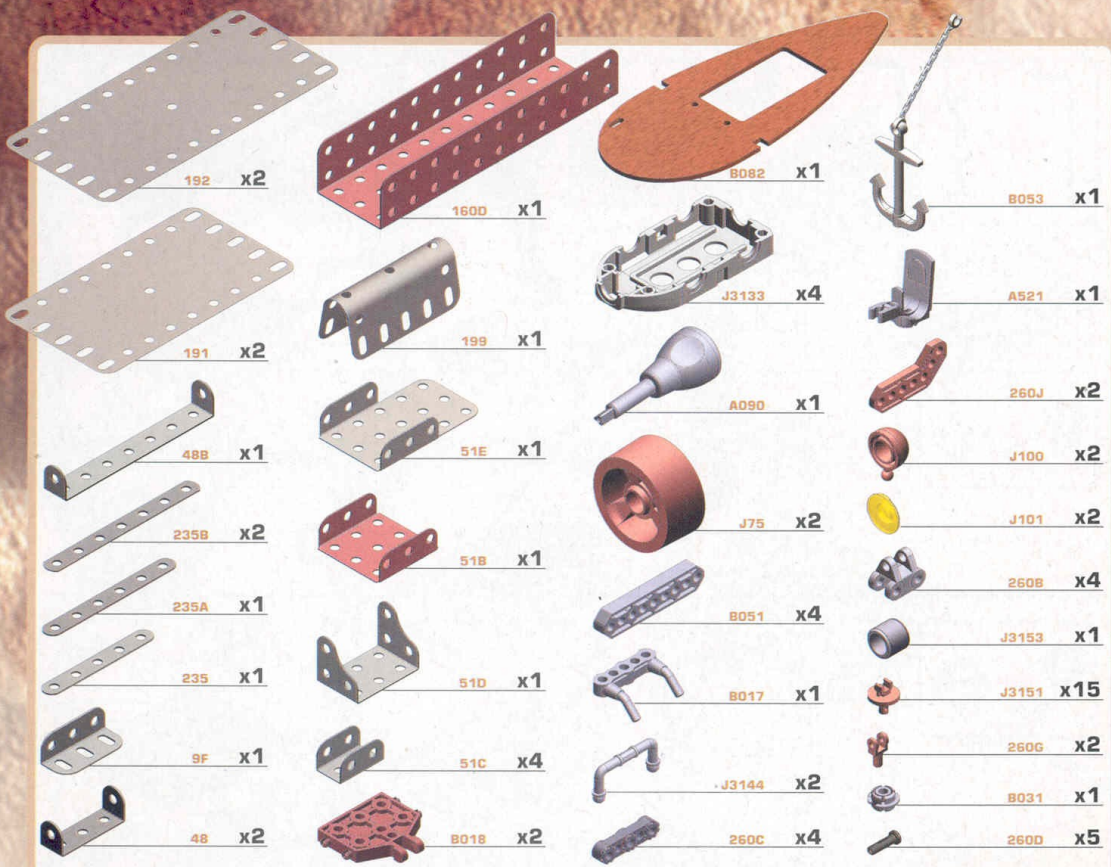

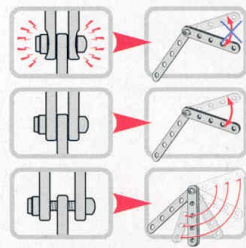
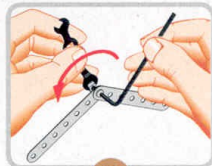
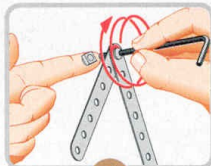
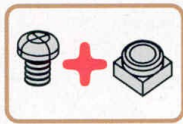
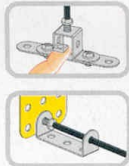
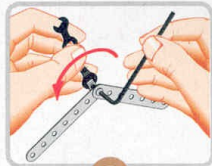
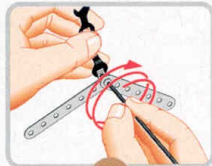
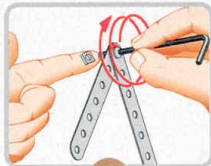
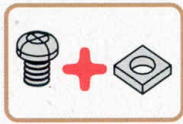
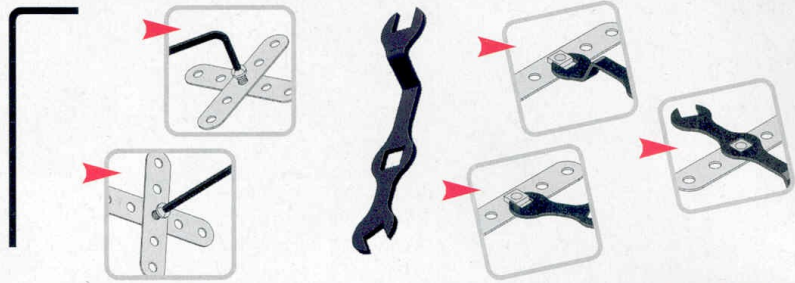
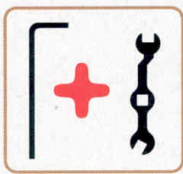

28 mm 1 1/8"		1
25,4 mm 1"		8
19 mm 3/4"		2
12 mm 1/2"		3
9,5 mm 3/8"		4
5,8 mm 15/64"		

Scale
Échelle
Maßstab
Scala

Escala
Schaal
Escala
Skala

Mittakaava
Målestok
Κλίμακα
スケール

1:1

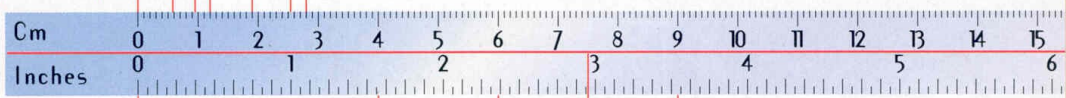

40 mm 1 1/2"	
60 mm 2 3/8"	
75 mm 3"	
90 mm 3 1/2"	

1

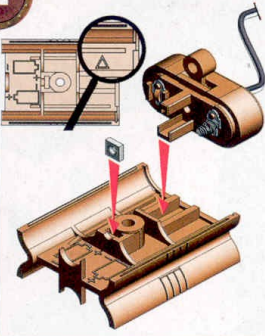

2



3

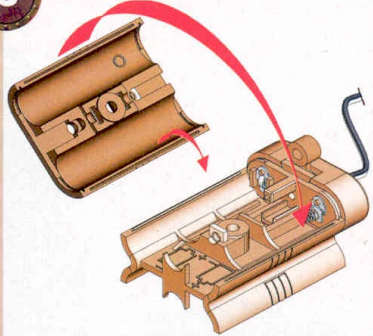

4

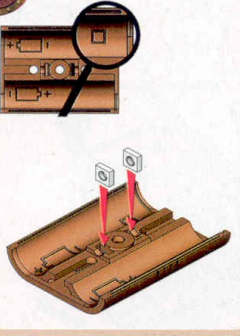

5

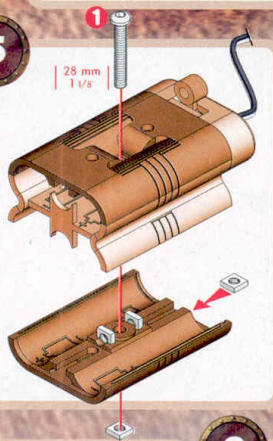

6

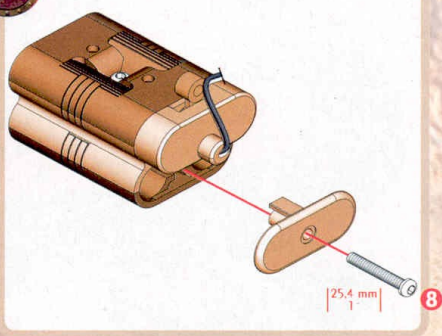

7

6 V Use 4 AA batteries.
(not included).

1.5V
AA
LR6
単三
x4



Do not mix old and new batteries. Do not mix alkaline, standard (carbon-zinc), or rechargeable (nickel-cadmium) batteries.

8

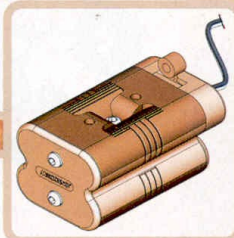
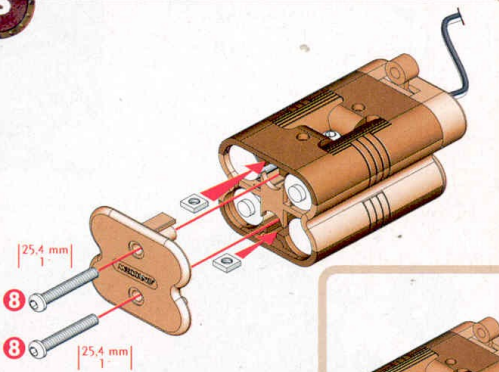

3 V Use 2 AA batteries.
(not included).

1.5V
AA
LR6
単三
x2

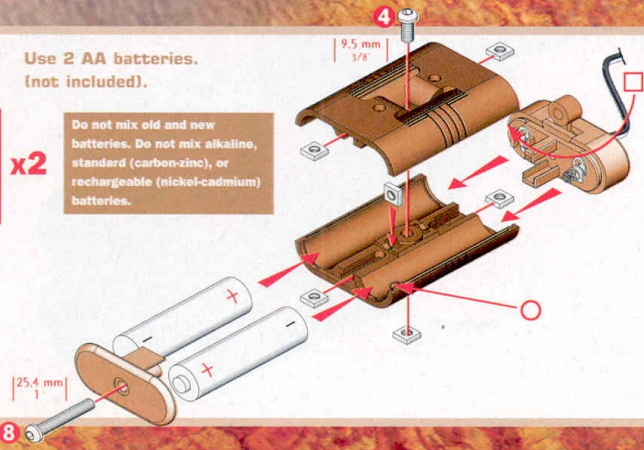



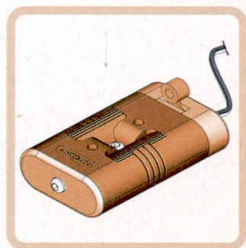

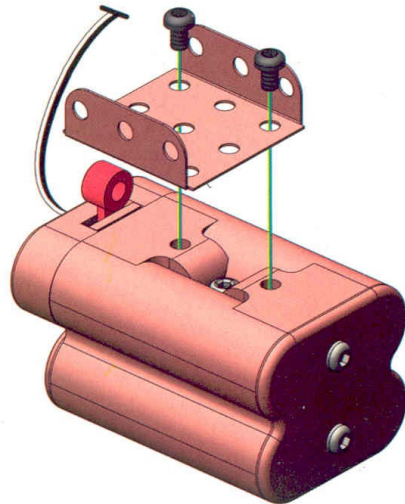
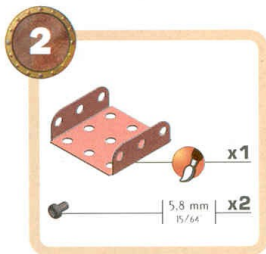
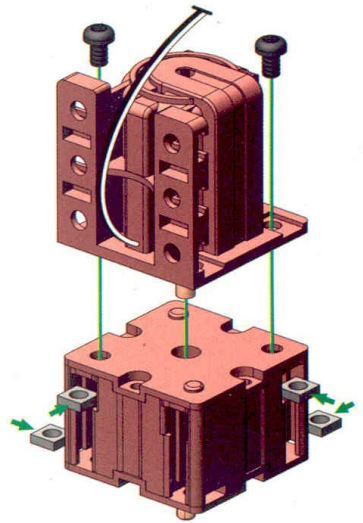
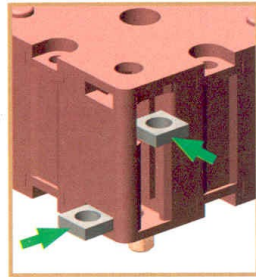
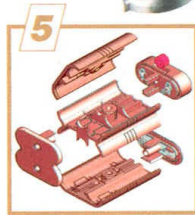
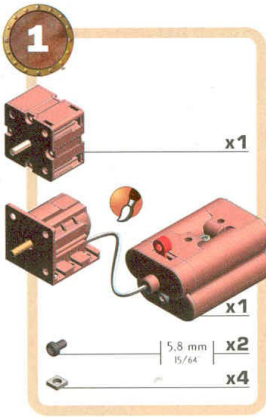
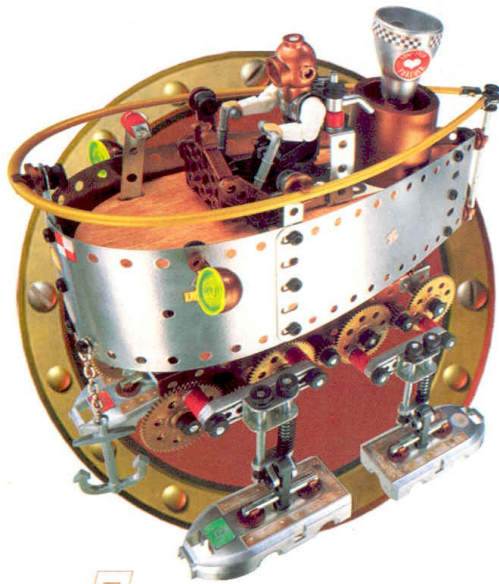

Do not mix old and new batteries. Do not mix alkaline, standard (carbon-zinc), or rechargeable (nickel-cadmium) batteries.



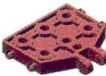

3

-  x1
-  x1
-  x1
-  5,8 mm 15/64 x4
-  9,5 mm 1/8 x4
-  x6

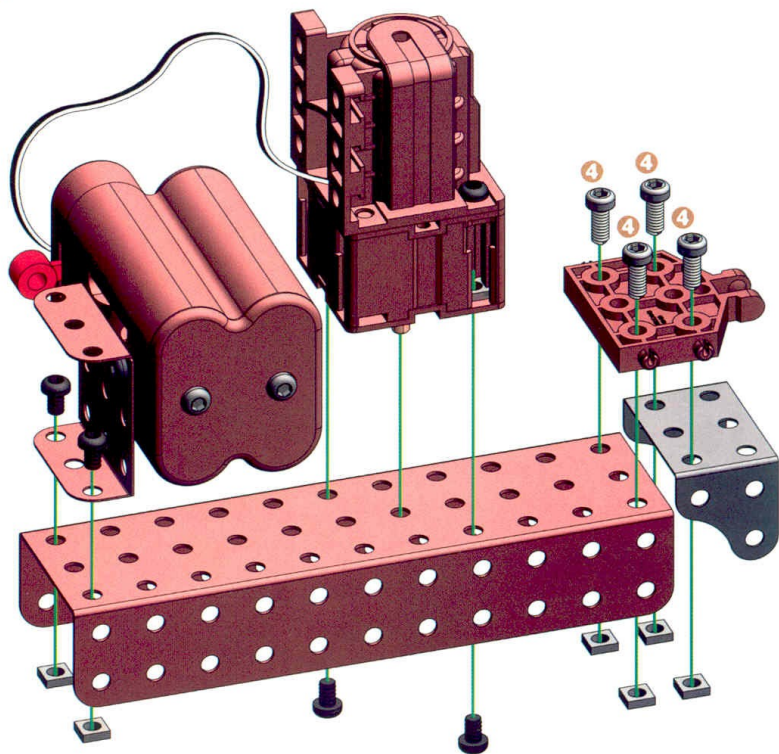

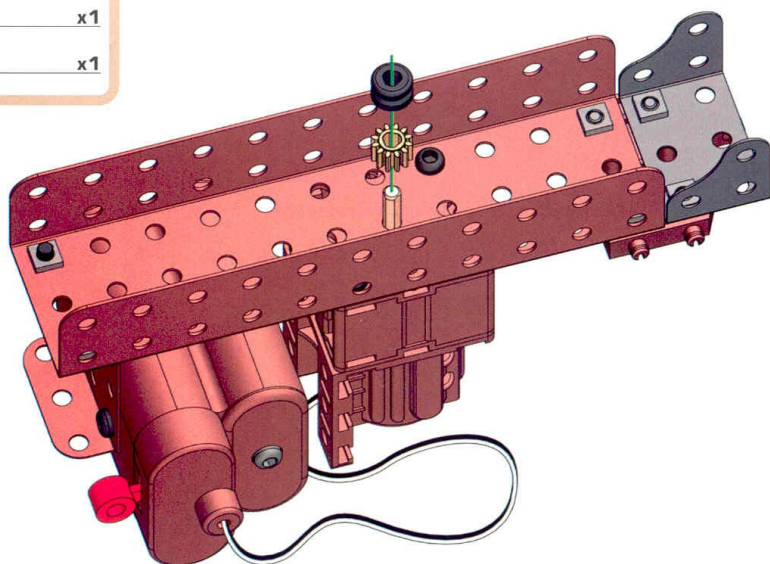

4

-  x1
-  x1







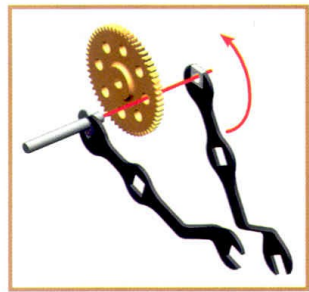
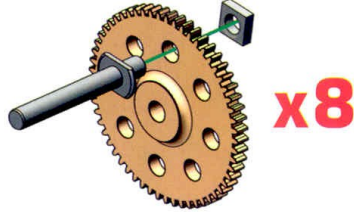



5

-  x8
-  x8
-  x8



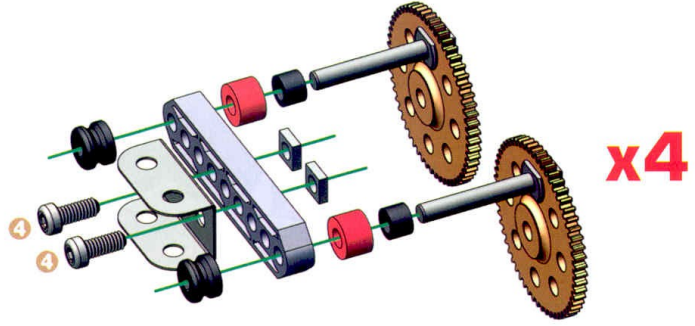

6

-  x4
-  x4
-  x8
-  x8
-  x8
-  x8
-  9,5 mm $\frac{3}{8}$ x8
-  x8





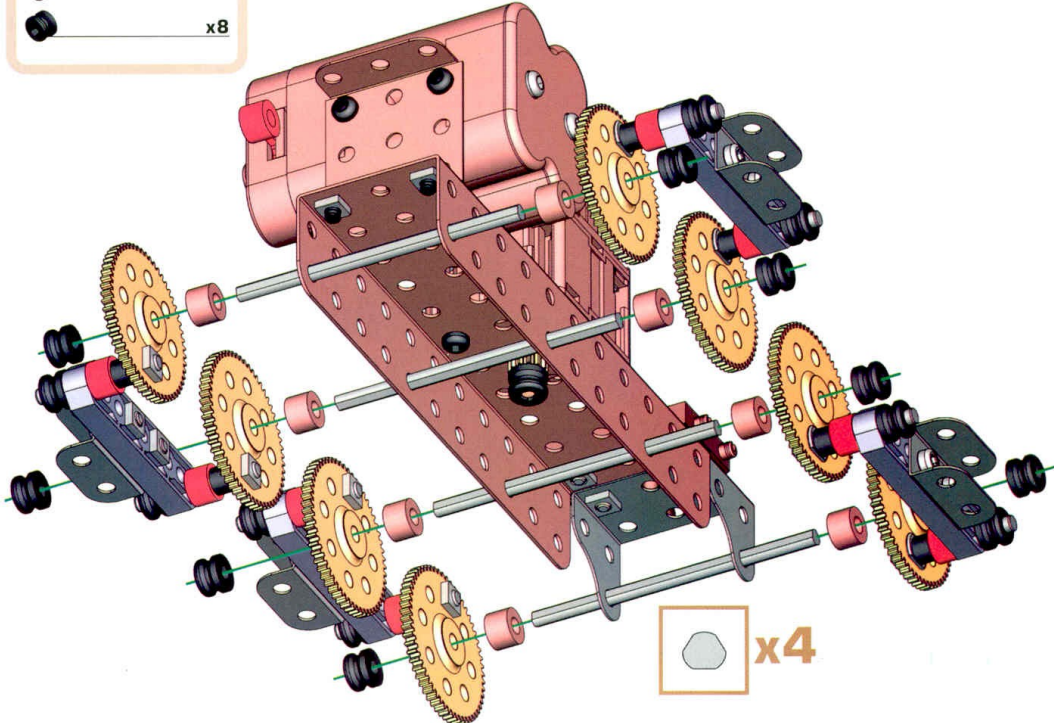

7

-  75 mm $\frac{1}{2}$ x4
-  x8
-  x8







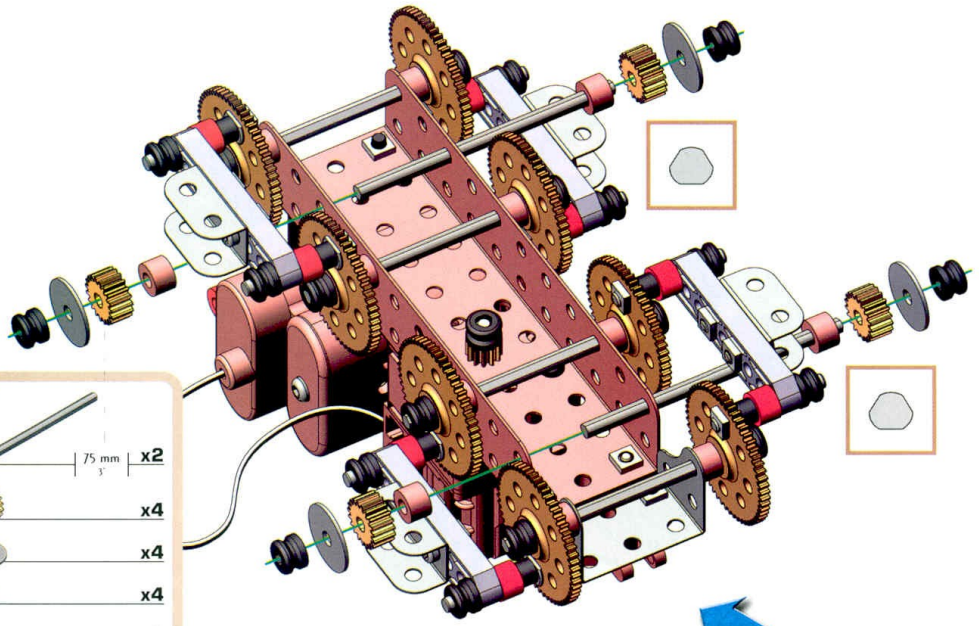



8

-  75 mm $\frac{3}{8}$ x2
-  x4
-  x4
-  x4
-  x4



9

-  75 mm $\frac{3}{8}$ x1
-  x1
-  x2
-  x2
-  x2
-  x2
-  x3
-  x1

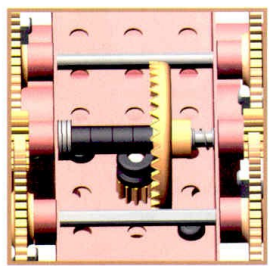
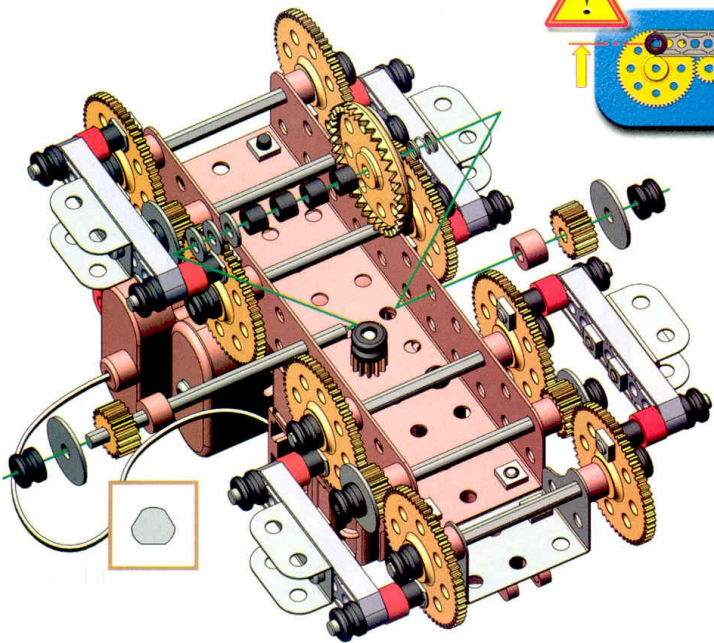
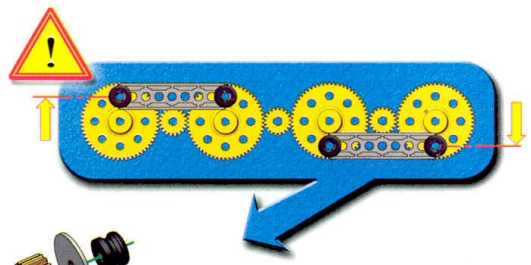
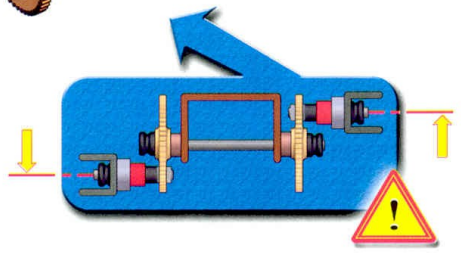

10

- 60 mm $2\frac{1}{2}$ x4
- 40 mm $1\frac{1}{2}$ x2
- x2
- x2
- x2
- x2
- x2
- x4
- x2
- x4

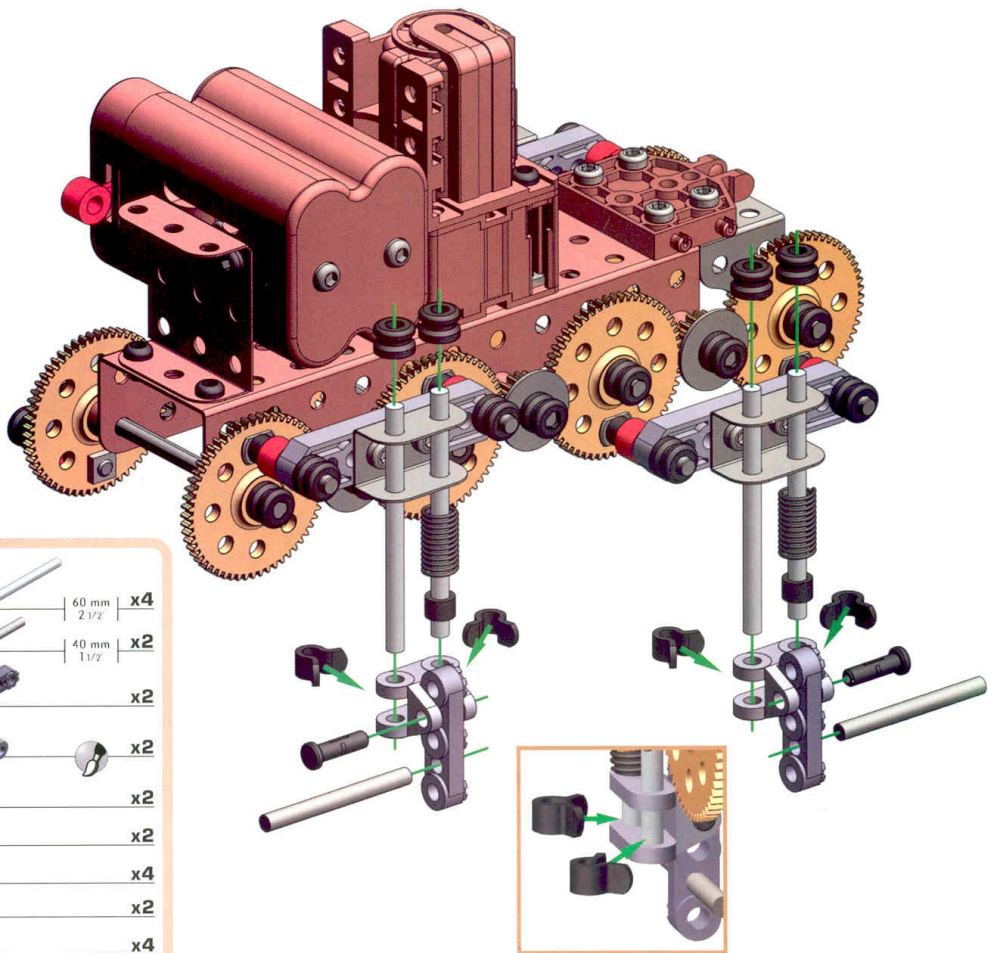

11

- x2
- x4

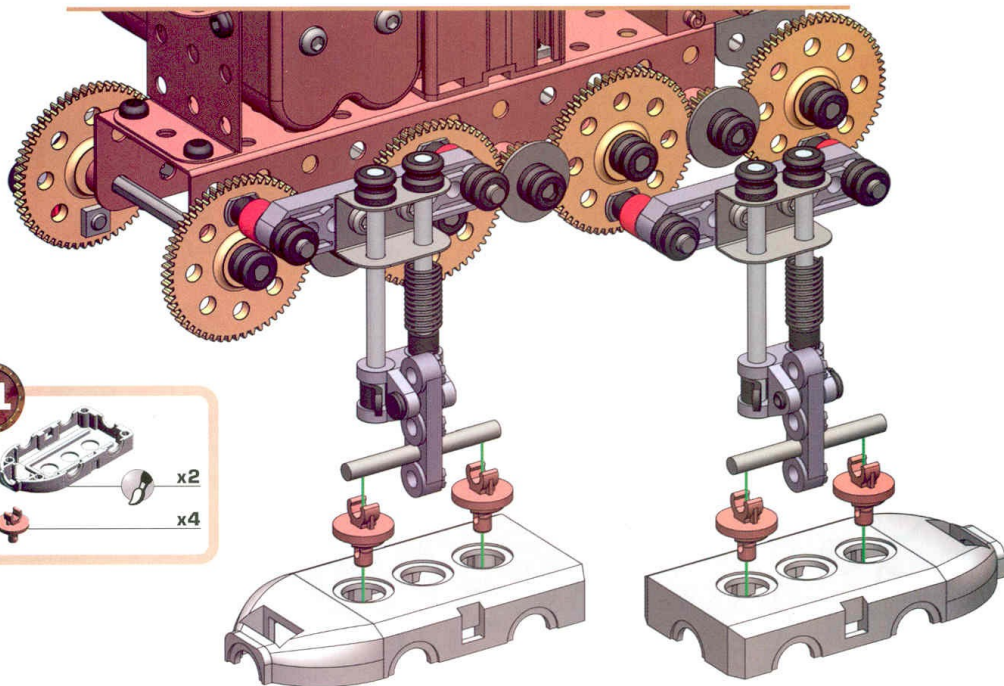

12

- | | | | | | | |
|--|-------|----|--|----|--|----|
| | 60 mm | x4 | | x2 | | x4 |
| | 40 mm | x2 | | x2 | | x2 |
| | | x2 | | x2 | | x4 |

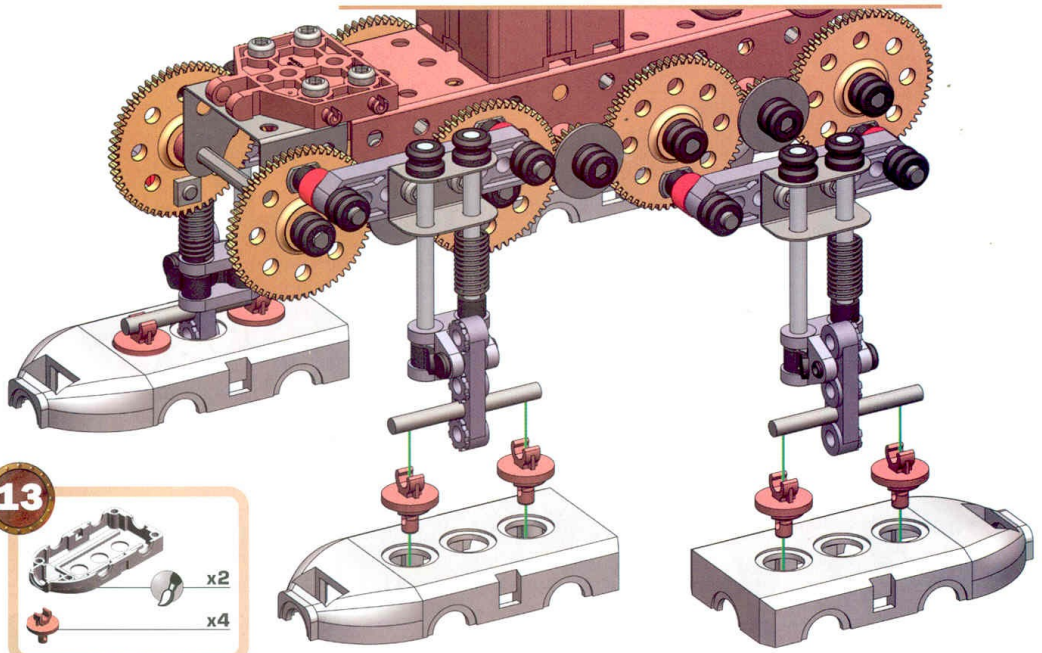
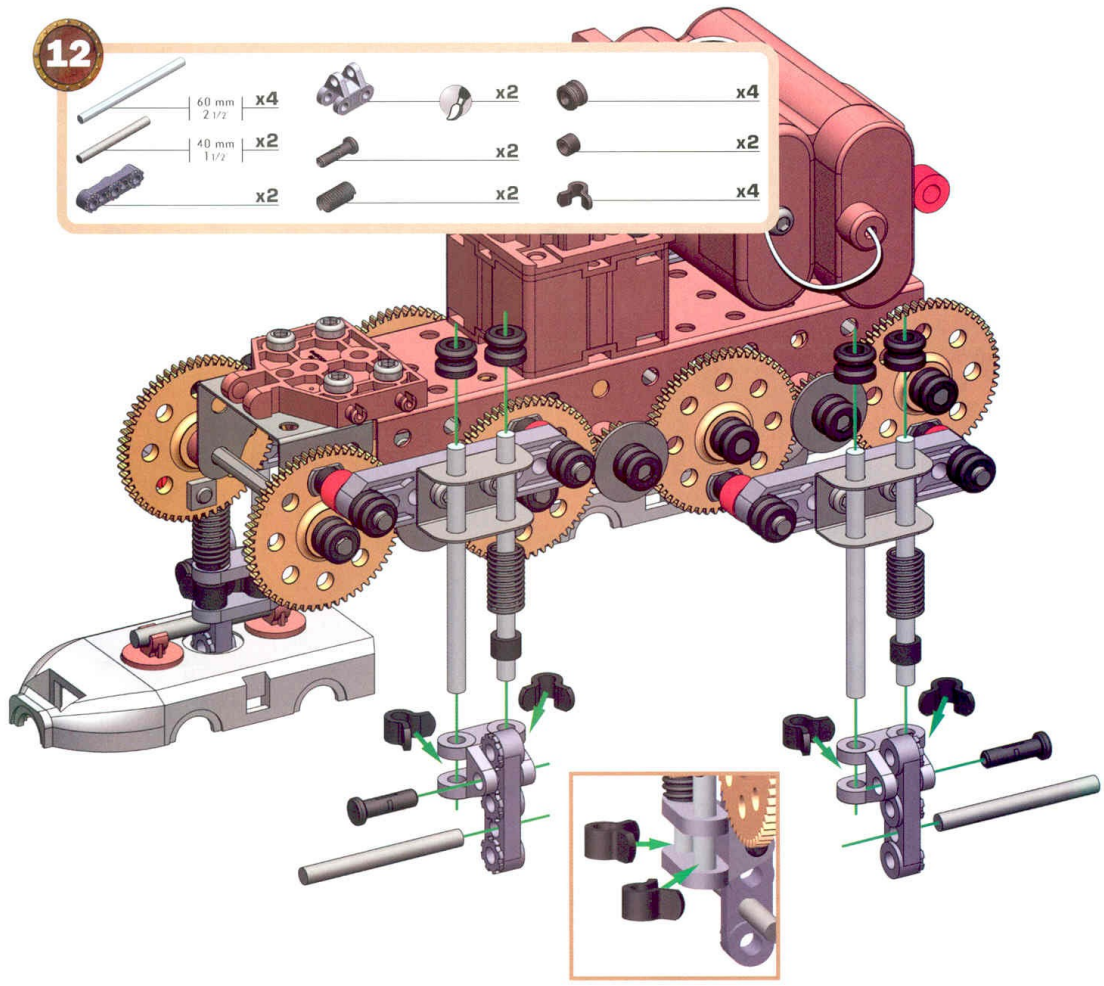









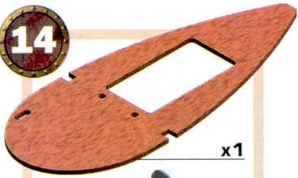

13

- | | | | | |
|--|--|----|--|----|
| | | x2 | | x2 |
| | | x4 | | |







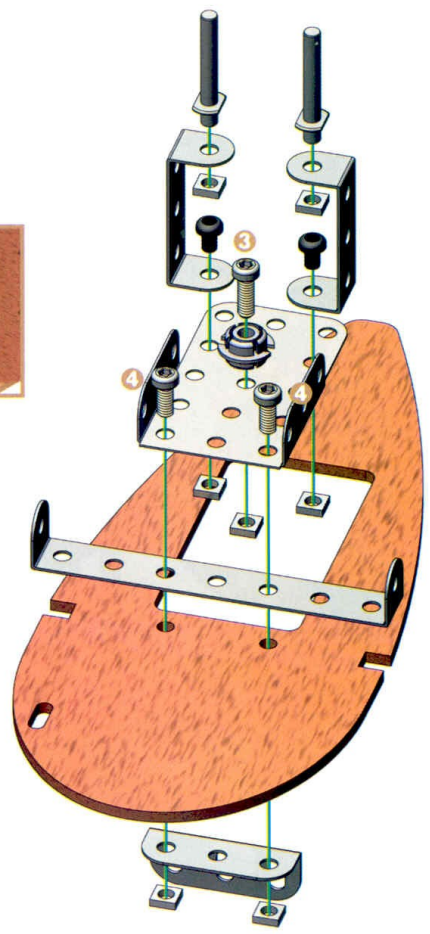

14

-  x1
-  x1
-  x1
-  x2
-  x1
-  x2
-  x1
-  12 mm | x1
-  9,5 mm | x2
-  5,8 mm | x2
-  x7







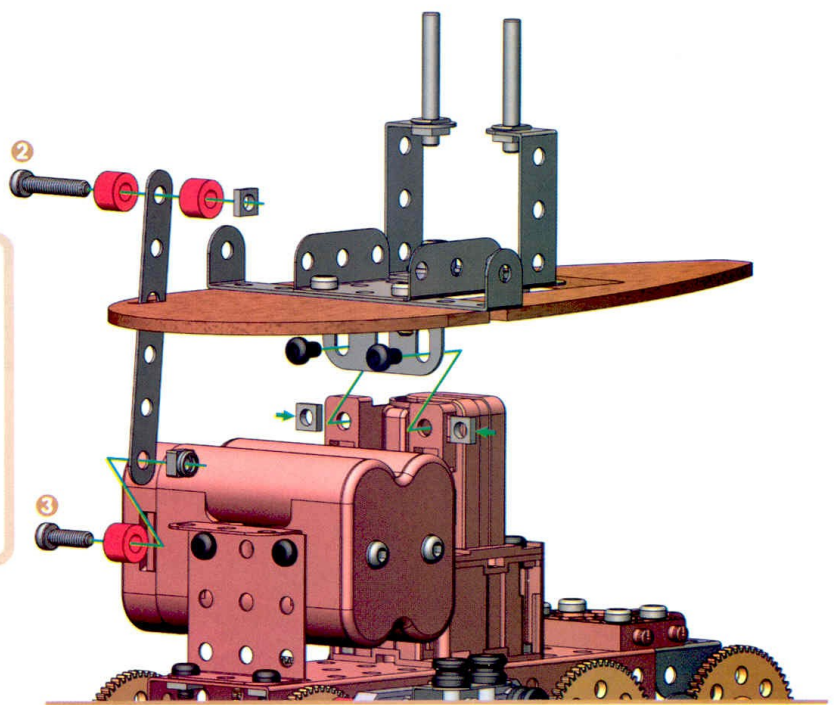

15

-  x1
-  x2
-  19 mm | x1
-  12 mm | x1
-  5,8 mm | x2
-  x1
-  x3



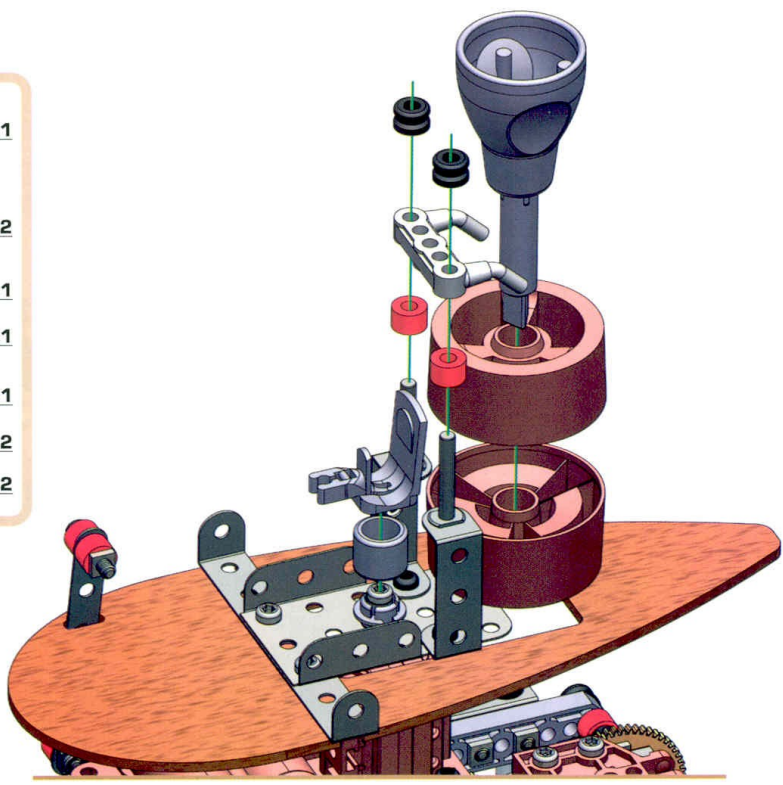

16

-  x1
-  x2
-  x1
-  x1
-  x1
-  x2
-  x2



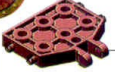

17

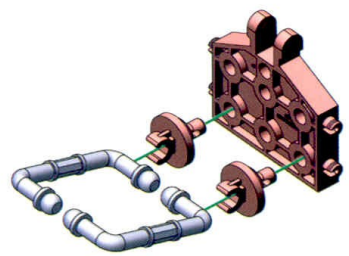
-  x1
-  x2
-  x2



18

-  x2
-  5,8 mm x4
-  15,64 x4

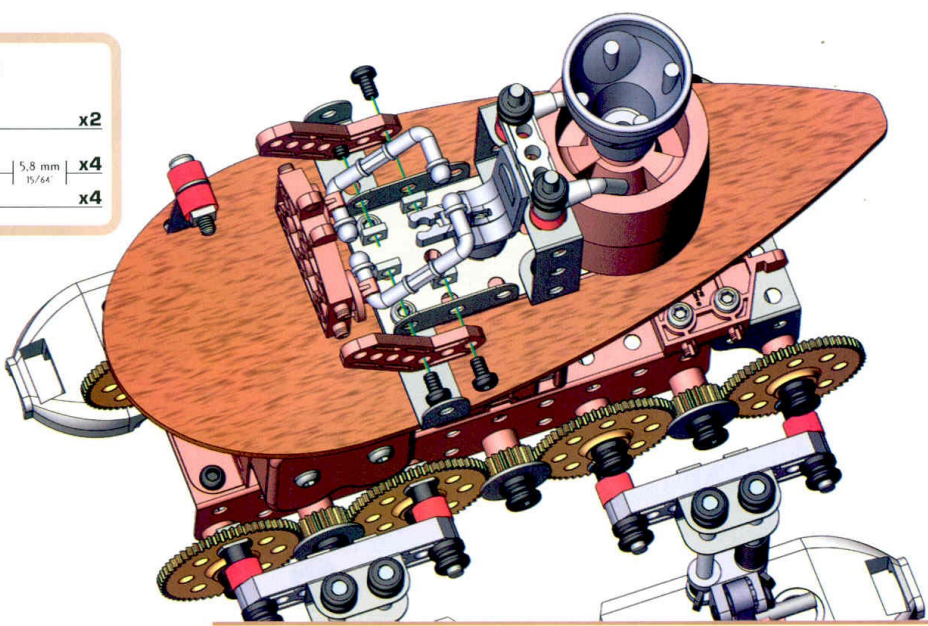

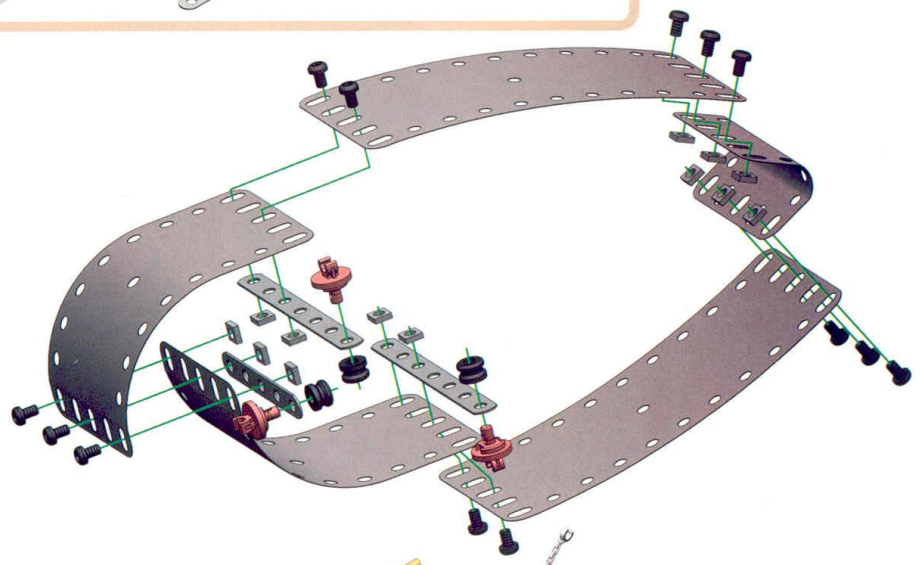
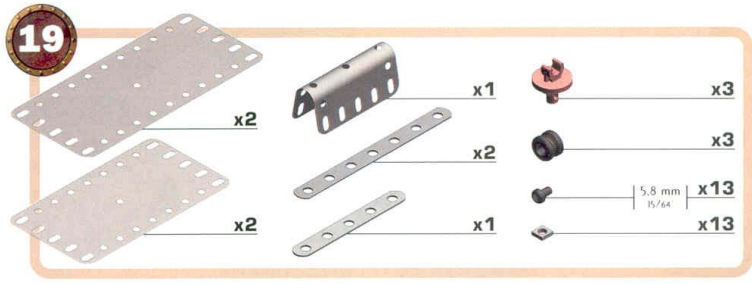

19

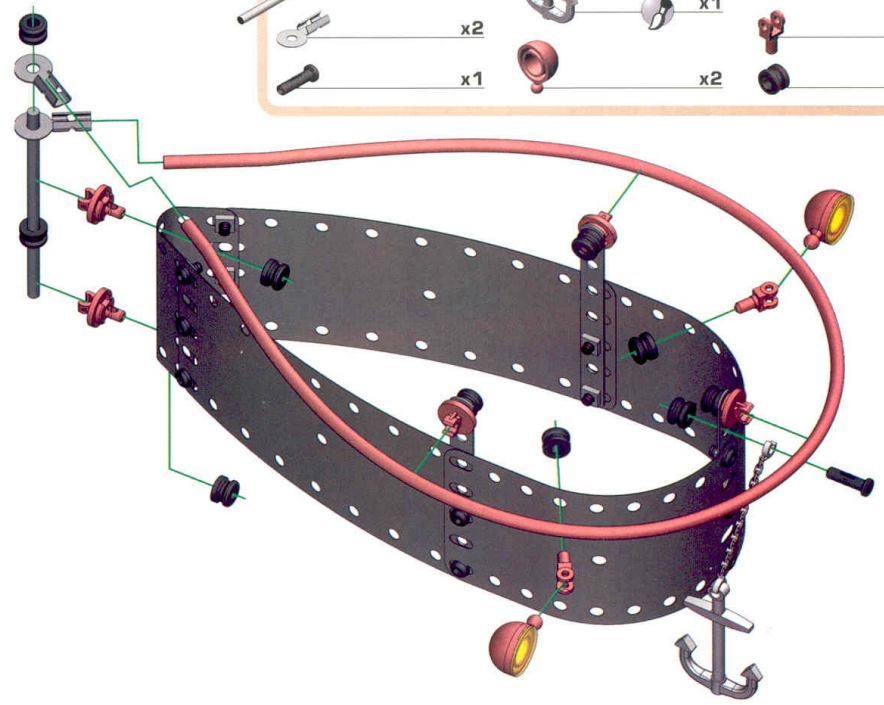
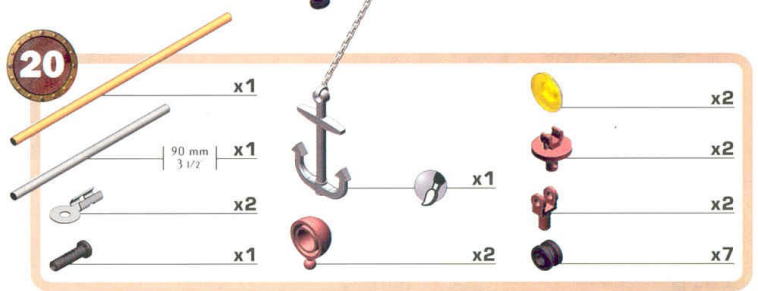

20







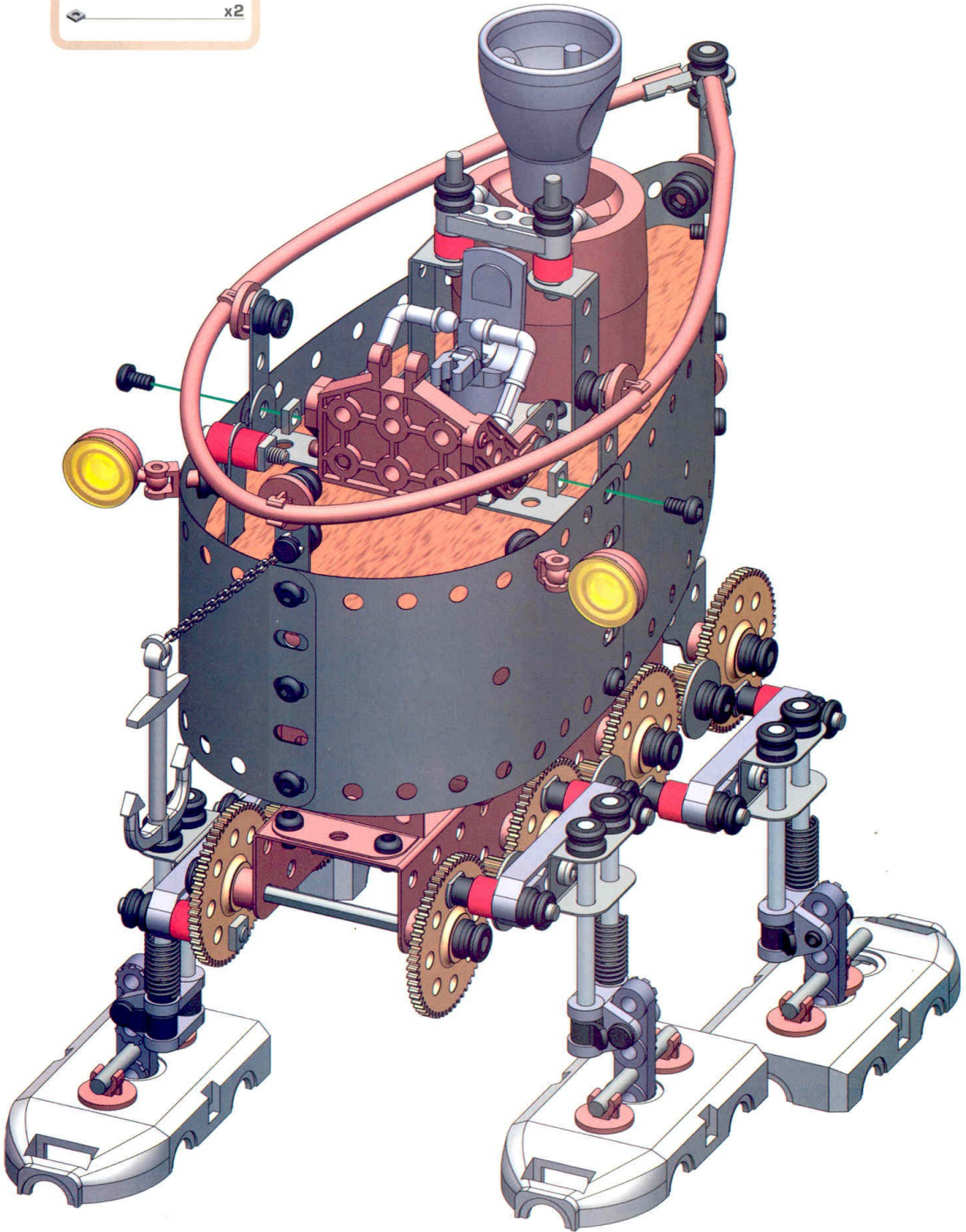

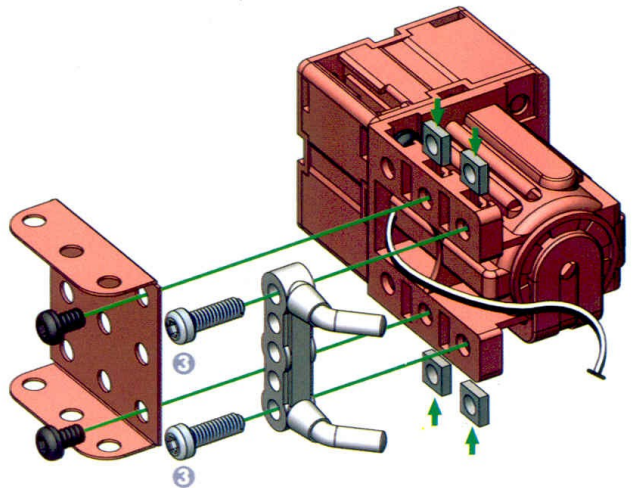
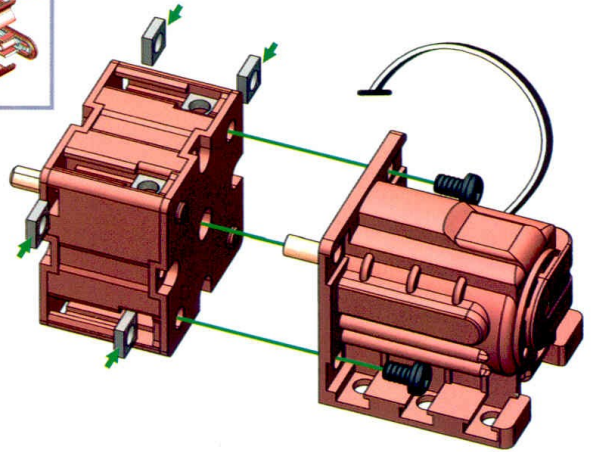
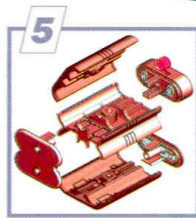
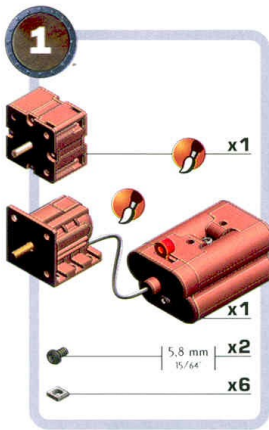
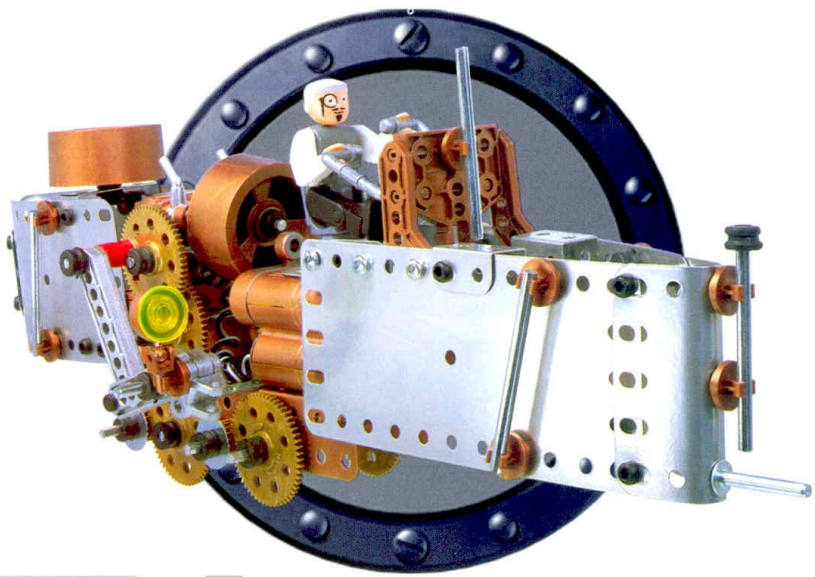
21

-  5.8 mm | x2
-  15/64 | x2





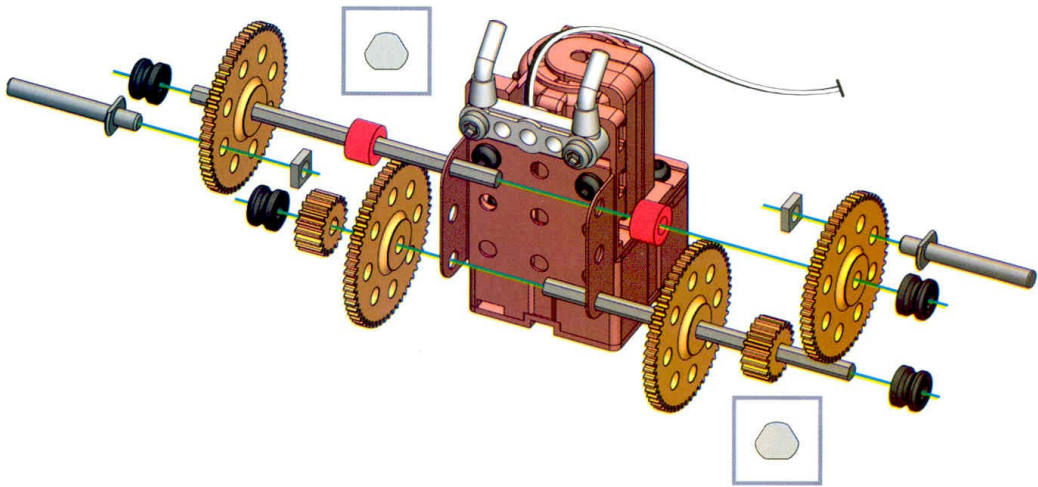
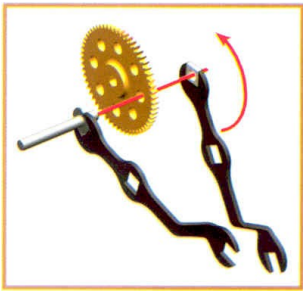

3

-  75 mm $\frac{3}{8}$ x2
-  x4
-  x2
-  x2
-  x2
-  x4
-  x2



4

-  x1
-  5,8 mm $\frac{15}{64}$ x2

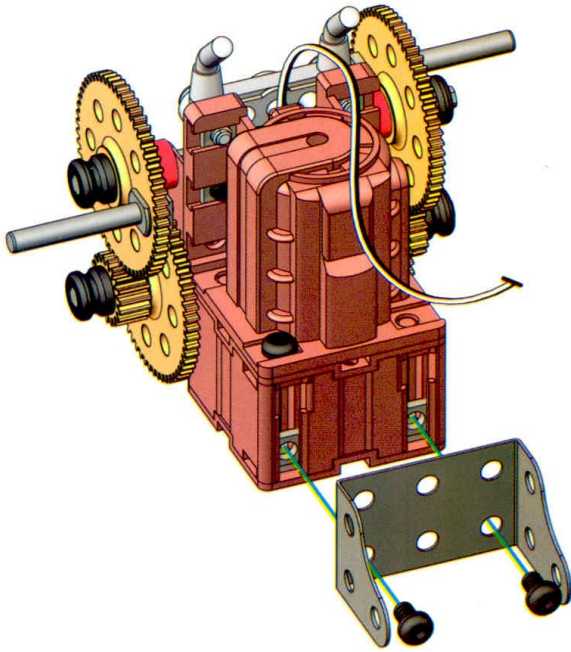

5



x1



40 mm
1 1/2 x1



x2



x3

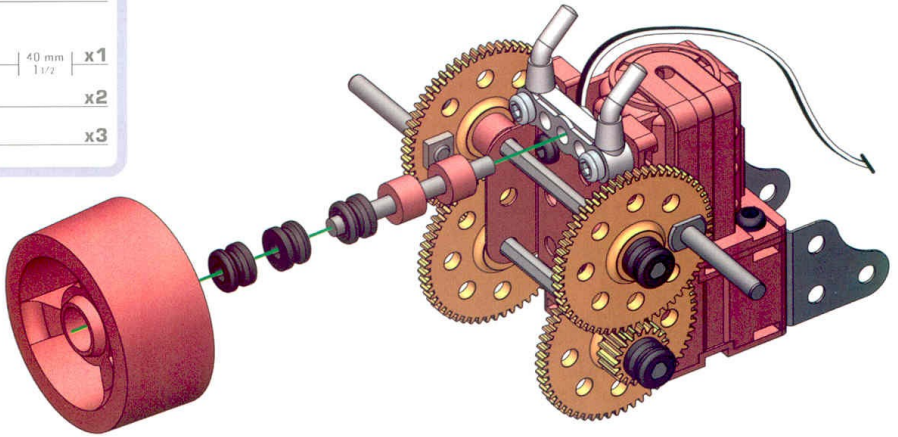

6

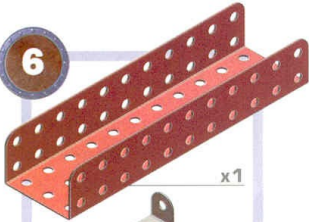

x1



x1



x1



x1









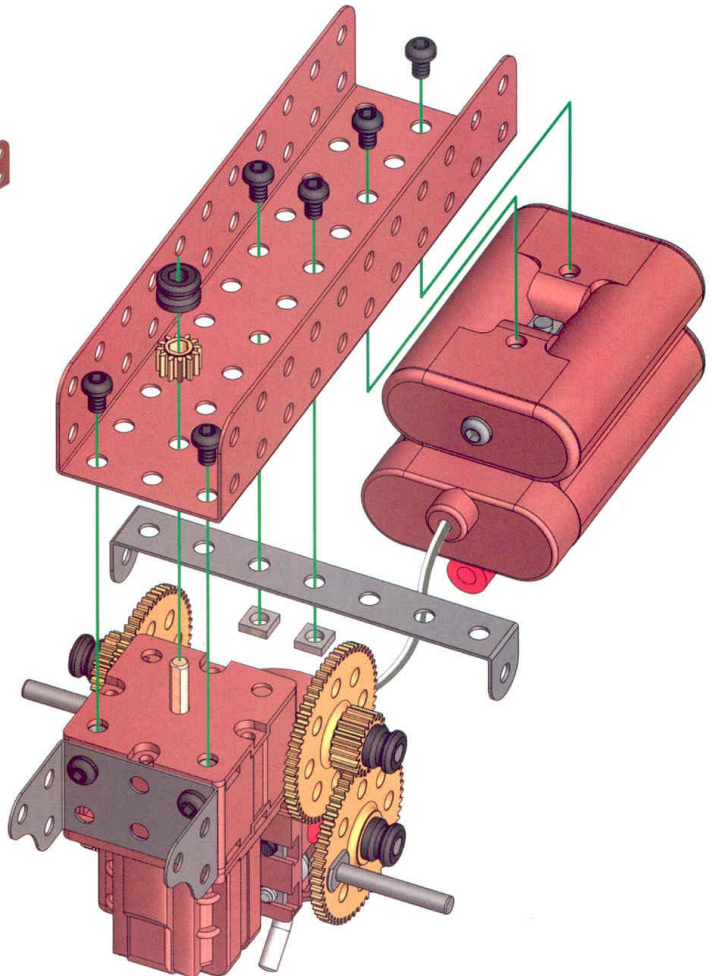



5,8 mm
3/64 x6



x2







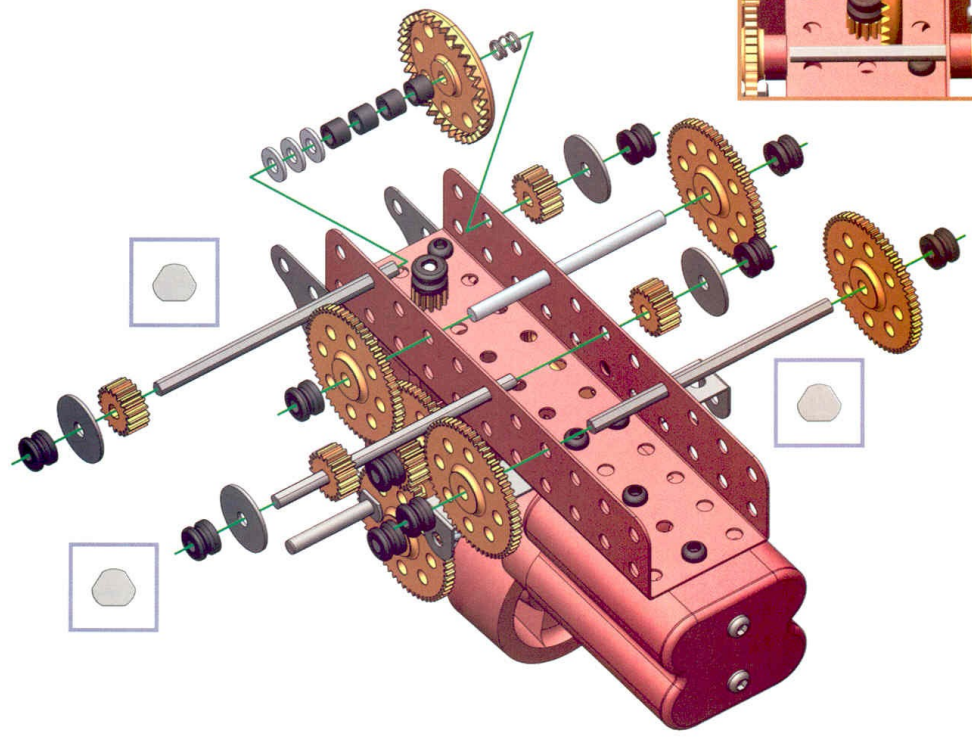
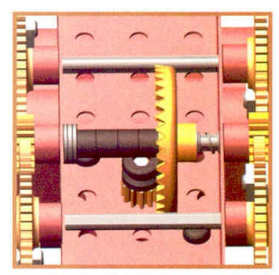





7

- | | | | | | | |
|---|-------|----|---|----|---|----|
|  | 75 mm | x3 |  | x4 |  | x4 |
|  | 60 mm | x1 |  | x1 |  | x8 |
|  | 2 1/2 | x4 | | |  | x4 |
| | | | | |  | x3 |
| | | | | |  | x1 |







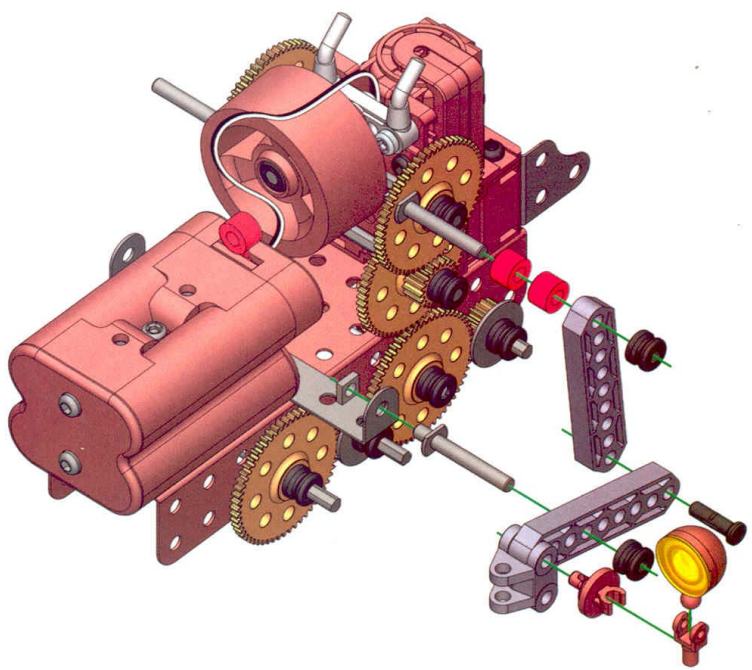



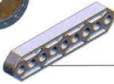



8

- | | |
|---|----|
|  | x2 |
|  | x1 |
|  | x1 |
|  | x1 |
|  | x1 |
|  | x1 |
|  | x1 |
|  | x1 |
|  | x2 |
|  | x2 |
|  | x1 |







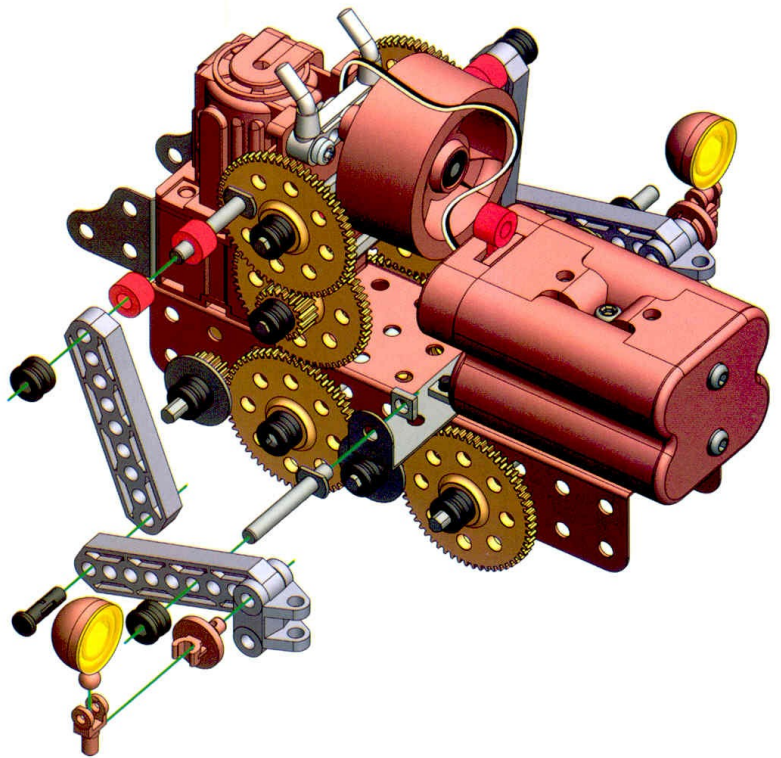

9

-   x2
-  x1
-   x1
-  x1
-  x1
-  x1
-  x1
-  x1
-  x2
-  x2
-  x1





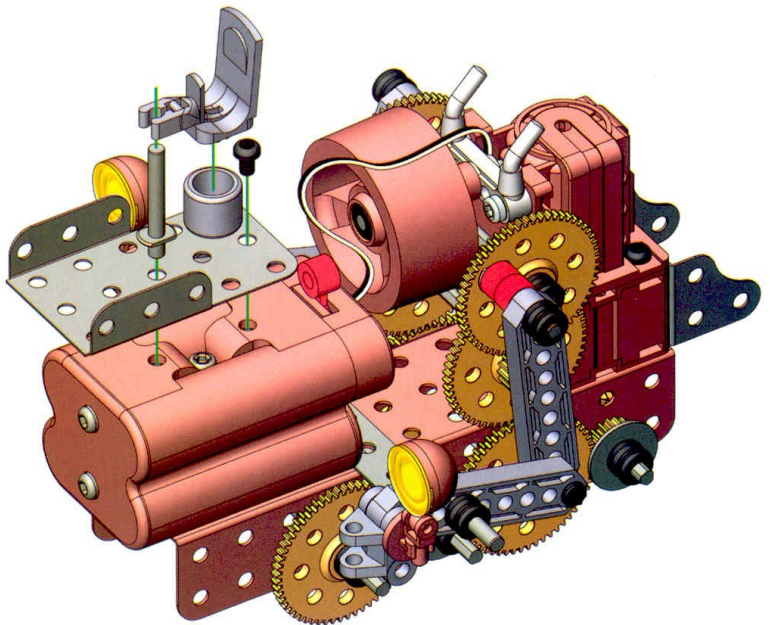

10

-   x1
-  x1
-  x1
-  x1
-  | 5,8 mm | x1
| 15/64"







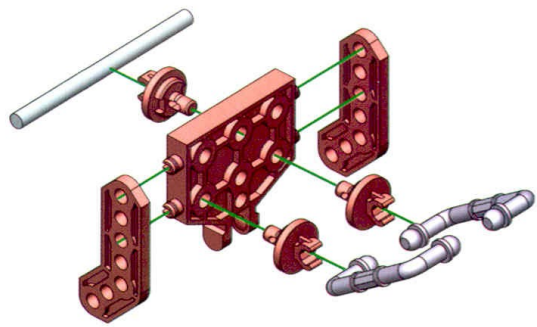

11

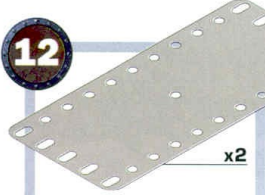
-  x1
-  | 60 mm | 2 1/2 | x1
-  x2
-  x2
-  x3







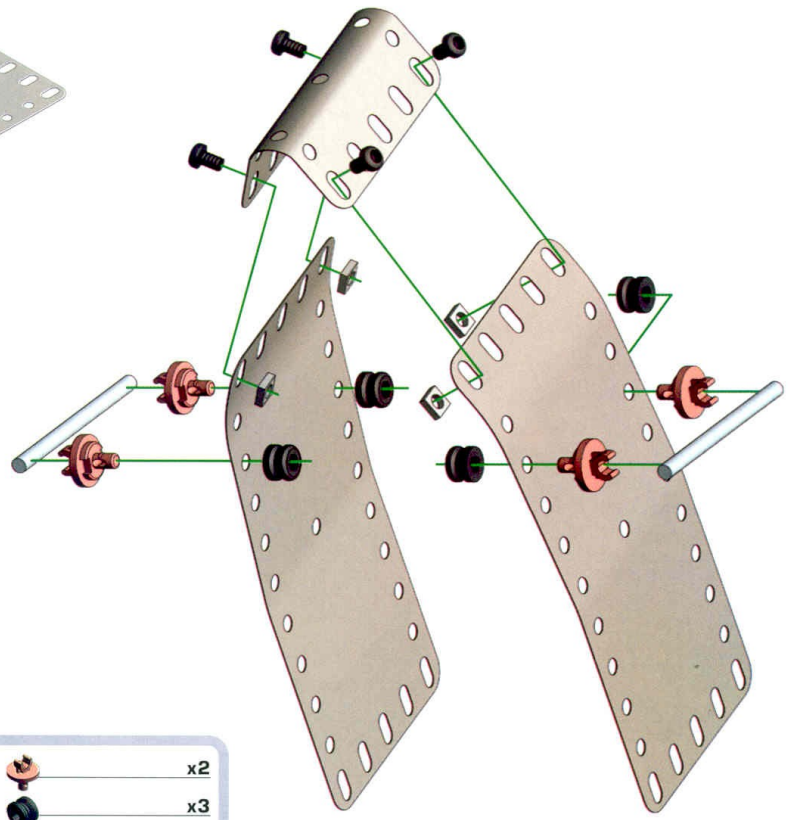



12

-  x2
-  x1
-  | 60 mm | 2 1/2 | x2
-  x4
-  x4
-  | 5.8 mm | 15/64 | x4
-  x4



13

-  | 60 mm | 2 1/2 | x1
-  x2
-  x3
-  x1
-  x2
-  | 9.5 mm | 3/8 | x2
-  | 5.8 mm | 15/64 | x2
-  x5
-  x2

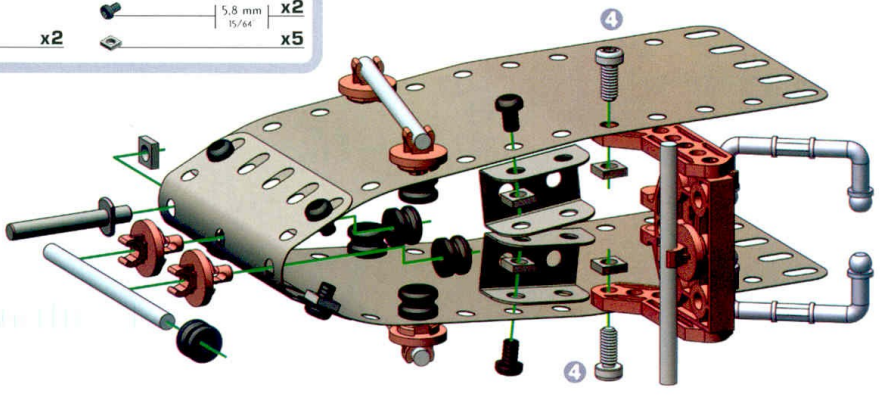

14



x2



2

19 mm
3/4

x1



4

9.5 mm
3/8

x3



4

x4

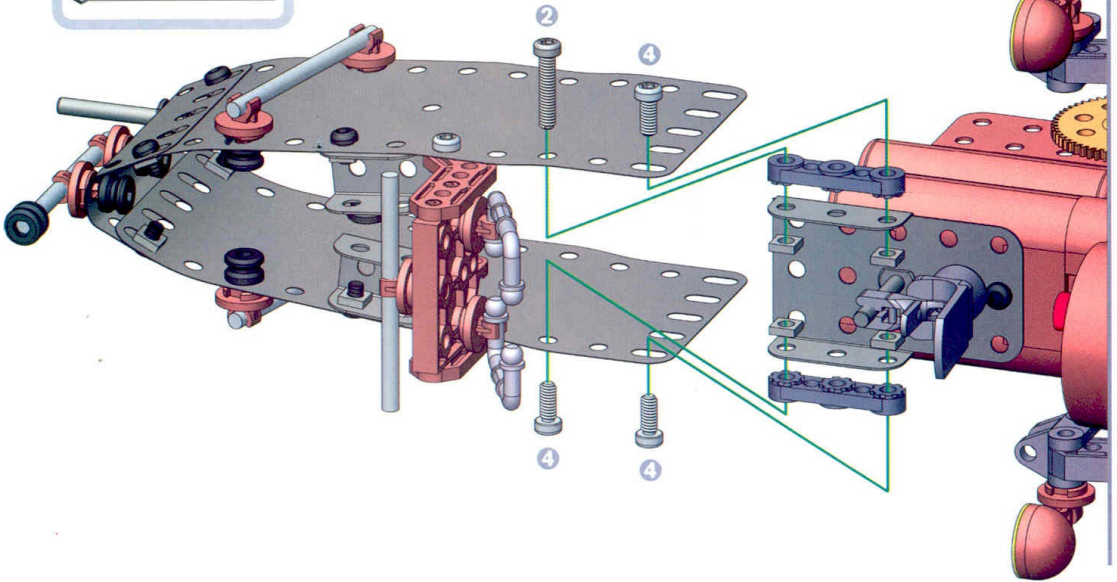

15

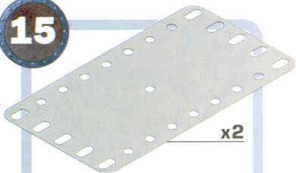

x2



x1



60 mm
2 1/2

x2



x4



x4



5.8 mm
15/64

x4



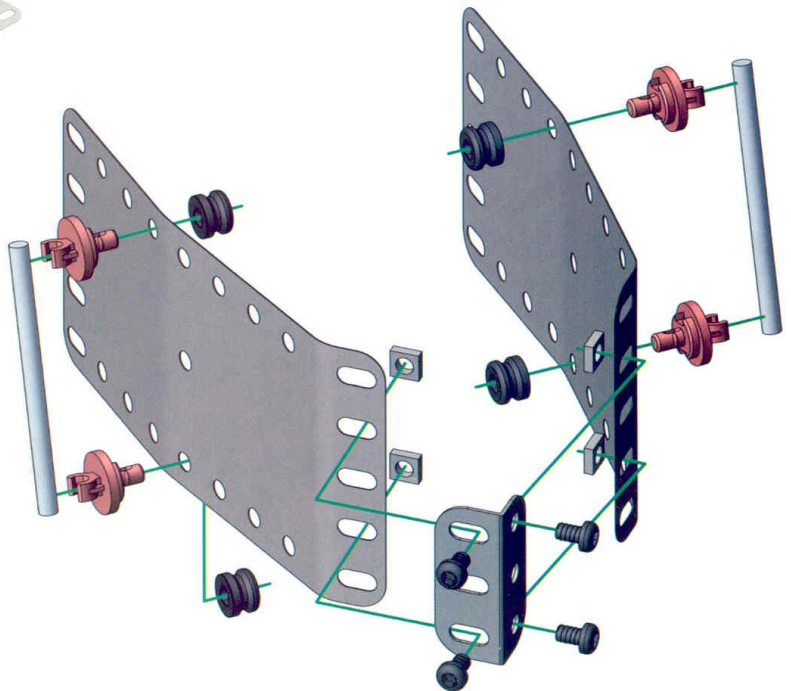

4

x4







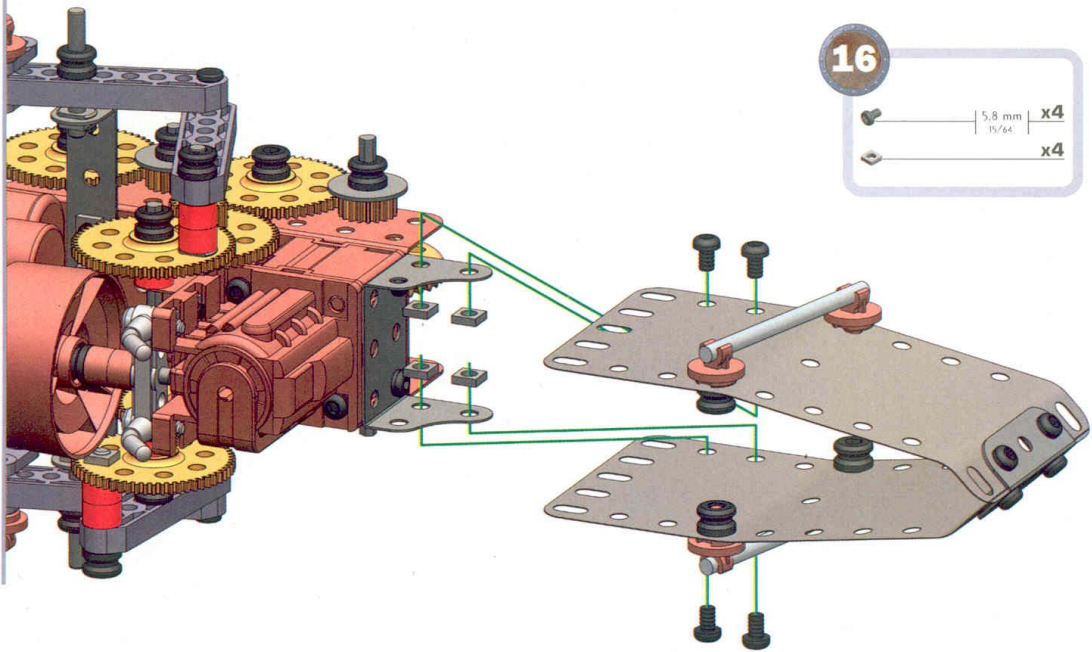

16

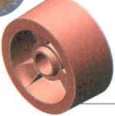
	5,8 mm	x4
	15/64"	x4



17

	x1		x1
	x1		x1
			x1
			5,8 mm x2
			15/64" x2

